

The development of large-scale thermal-plasma systems*

by N.A. BARCZA†

SYNOPSIS

This paper describes the development of large-scale thermal-plasma systems, which was motivated, in general, by the potential cost savings that could be achieved by their use as a replacement for the more conventional methods used in the generation of thermal energy. The anticipated cost savings arise not only from the use of plasma-generating devices but from the manner in which they have been interfaced with a furnace to process particular materials, mostly as fines.

Thermal-plasma systems fall into two categories: non-transferred-arc and transferred-arc devices. In general, transferred-arc devices have been interfaced with open-bath furnaces in which melting or smelting processes are carried out, while non-transferred-arc devices have normally been applied to shaft furnaces.

Water-cooled transferred-arc devices are somewhat limited in power (about 5 MW) because of the relatively low voltages (300 to 500 V) that can be attained in open-bath furnaces, where very long arcs are undesirable, and because only relatively low levels of current can be carried. Graphite electrodes can overcome the restriction of current, and power levels of 30 to 50 MW seem feasible, even with one electrode, if direct current is used. Multiple water-cooled devices are capable of attaining similar power levels, but the capital costs are much higher. Costs due to electrode wear are lower for water-cooled systems, but expensive gases are needed for transferred-arc devices.

Mintek conducted extensive pilot-plant work in which water-cooled devices were used initially but graphite electrodes were used subsequently to produce ferrochromium from fines. Transferred-arc open-bath configurations were used. This work led to a decision by Middelburg Steel & Alloys (MS&A) to install a 16 MVA furnace of semi-industrial scale to produce ferrochromium alloys based on the ASEA d.c. arc furnace developed for the Elred process.

Non-transferred-arc devices have attained reasonable scale-up to the 6 to 8 MW power level, and high-voltage operation, which is inherent in such devices, has enabled lower currents to be used. Nevertheless, multiple systems are still necessary to accommodate large-scale applications, and this can be costly from a capital point of view. The cooling requirements are large, and can represent a considerable loss of electric energy. Shaft furnaces equipped with non-transferred-arc devices are suitable for the processing of materials that have volatile species, e.g. silica or manganese, or where the shaft is used to prereducer oxides that are amenable to gas-solid reactions.

It is probably in the treatment of light and refractory metals that plasma technology will achieve its greatest development in the years to come. The energy requirements for the production of these metals are high, and very low oxygen potentials are necessary. These are factors that favour thermal plasma. Much developmental work is still needed in this interesting field. It should be remembered that electrically generated thermal energy is a unique temperature source that, in many instances, cannot be replaced technically or economically by the combustion of a fuel.

SAMEVATTING

Hierdie referaat beskryf die ontwikkeling van grootskaalse termieseplasmastelsels wat oor die algemeen gemotiveer is deur die moontlike kostebesparings wat verkry kan word deur die gebruik van sulke stelsels in plaas van die meer konvensionele metodes wat vir die ontwikkeling van termiese energie gebruik word. Die verwagte kostebesparings ontstaan nie net deur die gebruik van plasma-ontwikkelingstoestelle nie, maar deur die wyse waarop hulle van 'n koppelvlak met 'n oond voorsien is om bepaalde materiale, meestal fynfraksies, te verwerk.

Termieseplasmastelsels val in twee kategorieë: nie-oordraoog- en oordraoogtoestelle. Oor die algemeen is oordraoogtoestelle van 'n koppelvlak met oopbadoonde waarin smelt- en uitsmeltprosesse uitgevoer word, voor- sien, terwyl nie-oordraoogtoestelle gewoonlik vir skagoonde gebruik is.

Waterverkoelde oordraoogtoestelle is ietwat beperk wat hul krag betref (ongeveer 5 MW) vanweë die betreklik lae spannings (300 tot 500 V) wat bereik kan word in oopbadoonde waar baie lang boë ongewens is, en omdat daar net betreklik lae stroompeile gedra kan word. Grafietelektrodes kan die stroombeperking oorkom en kragpeile van 30 tot 50 MW lyk moontlik, selfs met een elektrode, as gelykstrom gebruik word. Veelvoudige waterverkoelde toestelle kan dergelyke kragpeile bereik, maar die kapitaalkoste is baie hoër. Die koste wat aan elektrodeslytasie toe te skryf is, is laer vir waterverkoelde stelsels, maar duur gasse is vir oordraoogtoestelle nodig.

Mintek het omvangryke proefaanlegwerk gedoen waarin waterverkoelde toestelle aanvanklik gebruik is, terwyl grafietelektrodes later gebruik is om ferrochroom uit fynerts te produseer. Oordraoog-oopbadkonfigurasies is gebruik. Hierdie werk het gelei tot 'n besluit deur Middelburg Steel & Alloys (MS&A) om 'n 16-MVA-oond, 'n half-industriële skaal, te installeer om ferrochroomlegerings te produseer wat gebaseer is op die ASEA-gs-boogood wat vir die Elred-proses ontwikkel is.

Redelike opskaling tot 'n kragpeil van 6 tot 8 MW is met nie-oordraoogtoestelle bewerkstellig en hoëspanningwerking, wat inherent is in sodanige toestelle, het dit moontlik gemaak om laer strome te gebruik. Veelvoudige stelsels is nietemin nog nodig om grootskaalse toepassings te akkommodeer en dit kan duur wees uit 'n kapitaaloo- punt. Die verkoelingsvereistes is groot en kan 'n aansienlike verlies van elektriese energie verteenwoordig. Skagoonde wat met nie-oordraoogtoestelle toegerus is, is geskik vir die verwerking van materiaal met vlugtige spesies bv. silika of mangaan, of waar die skag gebruik word vir die voorreduksie van oksiede wat vatbaar is vir gas-vastestof- reaksies.

Die plasmategnologie sal waarskynlik in die jare wat voorlê, die grootste ontwikkeling ondergaan in die behandeling van ligte en vuurvaste metale. Die energievereistes vir die produksie van hierdie metale is hoog en baie lae suurstof- potensiale is nodig. Dit is faktore ten gunste van termiese plasma. Daar moet nog baie ontwikkelingswerk op hier- die interessante terrein gedoen word. Daar moet onthou word dat elektries ontwikkelde termiese energie 'n unieke temperatuurbron is wat in baie gevalle nie tegnies of ekonomies deur die verbranding van 'n brandstof vervang kan word nie.

* Paper presented at the Colloquium on Recent Mining and Metallurgical Developments in the Eastern Transvaal, which was organized by The South African Institute of Mining and Metallurgy, and held in Witbank (Transvaal) in September 1985.

† Director, Pyrometallurgy Division, Council for Mineral Technology (Mintek), Private Bag X3015, Randburg, 2125 Transvaal.

© The South African Institute of Mining and Metallurgy, 1985. SA ISSN 0038-223X/\$3.00 + 0.00.

INTRODUCTION

South Africa has very large reserves of three of the most important oxide ores: iron, chromium, and manganese ores. In addition, it has reasonably abundant resources of carbonaceous reducing agents in the form of bituminous coals, and relatively low-cost electric power. As a result, up to about 50 per cent of the ores mined are converted locally to the metallic form. Conventional methods for the processing of these materials generally involve the need for lumpy-sized material, whereas fairly large quantities of fines are produced during mining activities. Although well-established, agglomeration techniques are costly, so that there is a strong motive for processes to be developed that use fine feed materials direct and that are flexible with respect to the choice of raw materials and energy source. Furthermore, the preheating of fine materials in, for example a fluidized-bed reactor, as a means of saving electrical energy, is potentially a very cost-effective method by which operating costs can be reduced at a relatively small additional capital expenditure.

The production of iron and steel is currently dominated by the route involving a blast furnace and a basic oxygen converter, whereas ferrochromium and ferromanganese alloys are produced in submerged-arc electric smelting furnaces. The pyrometallurgical industry has become a prolific user of electrically generated thermal energy for such ferro-alloy processes and for the melting of steel scrap in open-arc electric furnaces.

The elevated temperatures and thermodynamic energy required by the process can be obtained in two ways: by combustion, or by the use of electrical power. Electrical thermal energy is invariably generated by resistance heating, and only the conducting medium itself varies, namely solid, liquid, or gas. Hence, resistance heating can be achieved by the use of a resistance element (a rod or wire) or of the material of the actual process (e.g. coke or slag). Even induction heating depends on the resistance in the susceptor medium to the flow of induced current.

When resistance heating occurs in a gas phase, the term *arc* or *thermal plasma* is applied.

Arc heating is used where high temperatures, low oxygen potentials, large inputs of energy, or all of these are necessary. The smelting of ferro-alloys, which is highly endothermic, and the melting of steel scrap, for which a high energy flux is desirable, are typical applications of electrical arc heating.

In contrast, the blast-furnace process is based on the combustion of coke in the lower region of the shaft. A preheated blast of air (sometimes enriched with oxygen) is introduced via the tuyères. The product of combustion is mostly carbon monoxide (plus a little carbon dioxide), which is the reducing gas for the solid burden in the upper part of the shaft. The blast furnace therefore depends on coking coal of good quality, a raw material that is rapidly being depleted.

Large-scale thermal-plasma systems have been developed and tested in the ferro-alloy industry, which already uses electrical energy as the conventional source of thermal energy, and in the iron- and steelmaking industry, which uses combustion heating as well as open-arc electric and induction furnaces¹⁻³.

This paper describes the development of such plasma

systems, which was motivated, in general, by the potential cost savings that could be achieved by their replacement of the more-conventional methods used in the generation of thermal energy. The anticipated cost savings arise not only from the use of actual plasma-generating devices but from the manner in which they have been interfaced with a furnace to process particular materials, mostly as fines.

CONVENTIONAL ARC FURNACES

Conventional arc furnaces use three graphite or self-baking electrodes that are supplied with three-phase alternating current (a.c.) or, in some instances, six electrodes (i.e. three pairs, each pair being connected to a single phase of a three-phase system). There are two basic configurations: open-arc and submerged-arc.

Steel scrap is melted in the open-arc furnace, although the solid burden of scrap covers the hearth during the initial melt-down stage of this batch process. In the smelting of ferrochromium and ferromanganese alloys, the electrodes are submerged beneath the solid lumpy burden onto which the raw materials are piled. As smelting occurs, the burden collapses and additional raw materials are introduced into the furnace. The gases from the reactions in the high-temperature zones beneath the electrodes, mostly carbon monoxide, escape through the permeable burden of solids. The carbon monoxide in the off-gas is a potentially valuable source of chemical and thermal energy, but the quantity is limited compared with that generated by combustion processes, especially when prereduced ore is used.

Figs. 1 and 2 illustrate typical three-electrode open-arc and submerged-arc furnaces respectively. The development of the two types of furnaces in South Africa has shown considerable progress over the past twenty years^{4,5}. Open-arc furnaces have been up-rated by the introduction of more powerful transformers and the use of water-cooled roofs and side walls to permit operation at very high power levels, which have increased their productivity and efficiency. Larger submerged-arc furnaces have been built with greater transformer ratings. Ferrochromium furnaces with transformers rated at 48 MVA and operating at up to about 40 MW have been installed at the two major producers in South Africa, and ferromanganese furnaces rated at 75 and even 81 MVA have been installed. These units are large by world standards. Open-arc furnaces appear to have reached the stage where virtually all the improvements that are possible have been made, the only further noteworthy benefits that can still be obtained being reduced electrode consumption and preheating of the feed. Plasma technology is a potential means by which electrode costs can be reduced, the power density of an operation can be increased, and the throughput rate can be increased even further, but considerable developmental work is still needed.

The development of submerged-arc furnaces also appears to have reached a plateau where relatively little further progress can be made in the design and operation of these furnaces. Ferrochromium smelting is still constrained by relatively low power densities (less than 0,5 MW/m²), and high losses of unreduced chromium ore in the slag are typical. Ferromanganese smelting is

Fig. 1—A conventional modern open-arc furnace for the melting of steel scrap

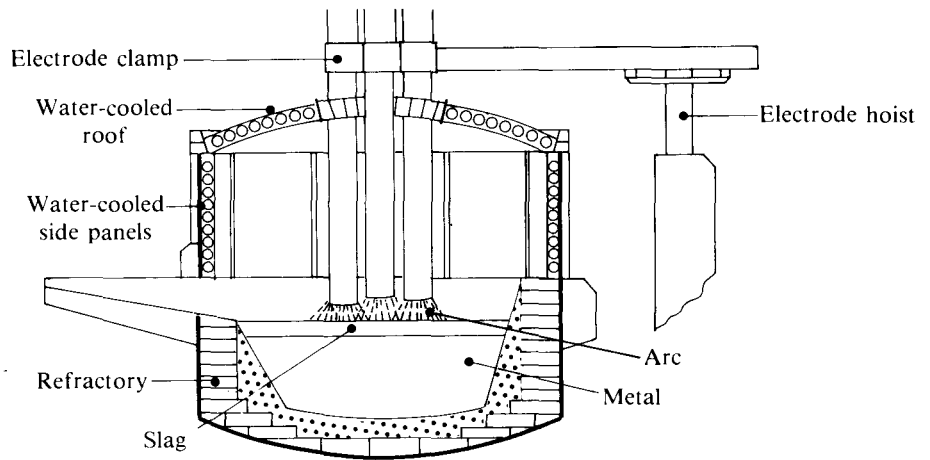
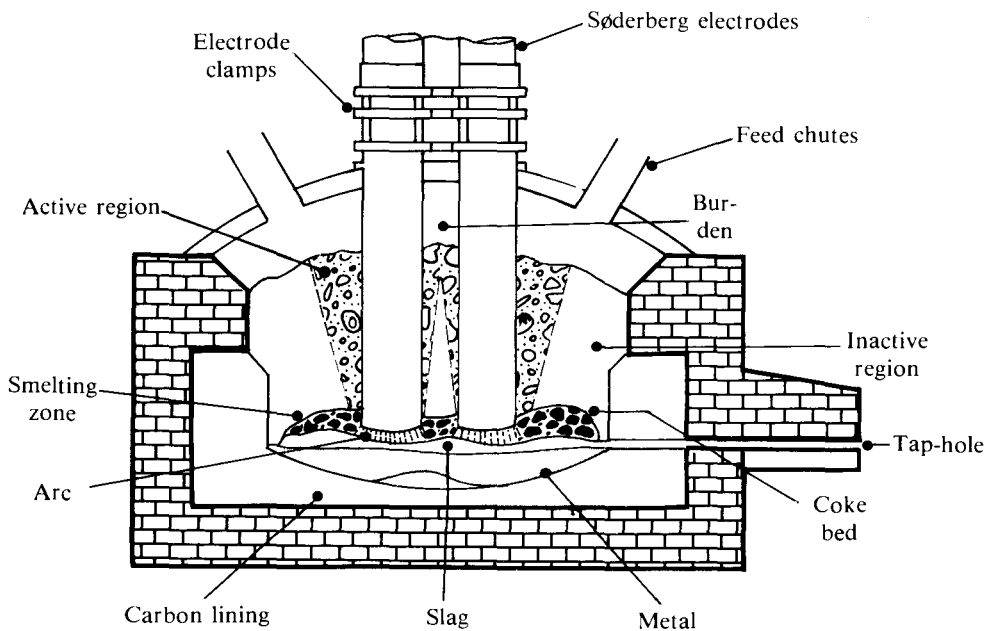

Fig. 2—A conventional submerged-arc furnace for the smelting of ferro-alloys



characterized by relatively high losses of manganese oxide in the slag (typically 20 per cent by mass) and low-resistance operation that gives rise to poor power factors, i.e. low megawatts given high megavolt-ampères. The electrical resistance of these processes is determined largely by the raw materials used, and this interrelation can have an adverse effect on the stability of the operation, especially at high power levels. Both of these processes therefore depend on carefully selected raw materials; direct control of the operations is difficult owing to their very long time constants (days).

On the positive side, however, these furnaces have a fairly high electrical-to-thermal efficiency, typically 85 to 90 per cent, and they require rebuilding only after several years of operation. Furthermore, the chemistry of the processes, although somewhat constrained, is virtually self-regulating and only limited amounts of high-temperature volatile species are lost to the off-gases.

The constraints associated with conventional furnaces and the search for ways in which capital and operating costs can be decreased have prompted the industry to give

serious consideration to plasma technology and to non-electrical methods for the conversion of oxide ores to metallic products, i.e. direct generation of thermal energy by the combustion of a fuel such as coal with air or oxygen.

THERMAL PLASMA DEVICES

A plasma device can be defined, in essence, as a system in which one uses a controlled input of gas of chosen composition or special water-cooled metallic electrodes with a specially designed power supply, or both, primarily to stabilize the arc or to increase the maximum voltage that can be used. The controllable plasma arc permits one to use a number of unique methods to interface the transfer of electrical energy from the device to meet the thermal energy requirements of the process. This is in distinct contrast to conventional arc-furnace processes, where little or no control of the arcing characteristics is exercised. The controlled feeding of materials into, or close to, the plasma-arc zone is a further specific aspect in which the overall plasma system differs from conventional arc-

furnace processes, where the introduction of feed materials into the reaction zone during smelting or melting is virtually uncontrolled.

Design of Thermal Plasma Devices

Thermal plasma systems fall into two categories, namely non-transferred-arc and transferred-arc devices⁶ (Fig. 3). The plasma arc is generated between at least two electrodes: a cathode from which electrons are emitted, and an anode at which electrons are absorbed. The medium between the electrodes is a gas phase that is rendered electrically conductive by heating and the ionization of some of the atoms (or molecules after dissociation). The configuration and shape or form of the electrodes largely determine the category of the device and of the overall plasma system, i.e. power supply, feed system, furnace, etc. The scale-up of plasma devices depends on several factors, but especially on the electrodes.

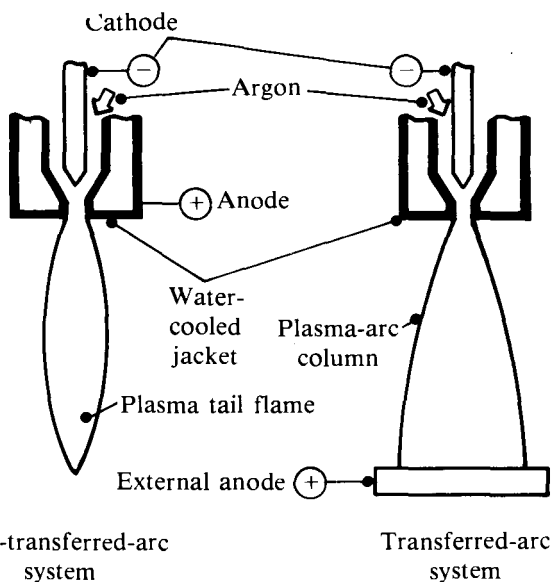

Fig. 3—Non-transferred-arc and transferred-arc systems (after Barcza and Stewart⁶)

Electrode Shape and Material

Thermal plasma can be generated from electrodes of two basic shapes, namely a rod (or button) and a tube (Fig. 4). The rod can be either pointed or flat. The diameter of the tip or base of the rod type or of the annulus of the tubular type is one of the key design considerations. The rod type is used most often for transferred-arc plasma devices, and is usually made of thoriated tungsten or graphite. The water-cooled rod-type electrode is normally surrounded by a sheath or jacket, which is also water-cooled, to direct a fairly small flow of gas around the tip of the electrode. This jacket is usually made of copper or sometimes stainless steel. Fig. 5 shows a transferred-arc device with a rod-type electrode made of thoriated tungsten⁷. The rod is the cathode, and the anode contact is made via the material being processed, i.e. it is external to the device under normal operation. However, the nozzle can be used as a temporary

anode during initiation of the plasma arc, i.e. prior to transfer of the arc to the process. Once the arc has been transferred, the process becomes part of the electrical circuit.

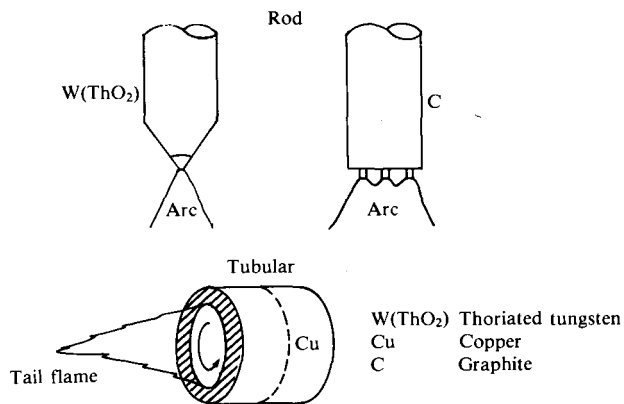

Fig. 4.—Shapes of electrodes

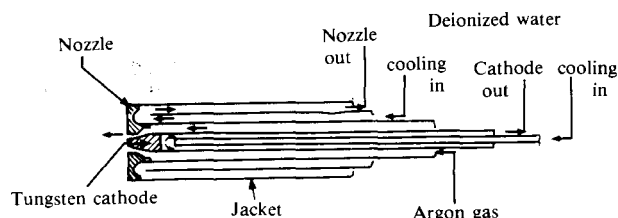

Fig. 5—A transferred-arc device (after Page⁷)

The tubular-type electrodes are sometimes closely spaced in non-transferred-arc plasma devices, although many devices have spaced or segmented electrodes. One end of the device is usually closed; the other end is open, and it is from the open end that the plasma-heated gas is projected. Water-cooling of the tubular electrodes, which are made of copper or steel, is essential. The gas velocity through the annulus is very high and is normally introduced tangentially so that a vortex effect is created, which causes the arc attachment to move over the surface of the electrodes. Figs. 6 and 7 illustrate typical non-transferred plasma-arc devices^{8,9}. Tubular electrodes are sometimes used in transferred-arc devices.

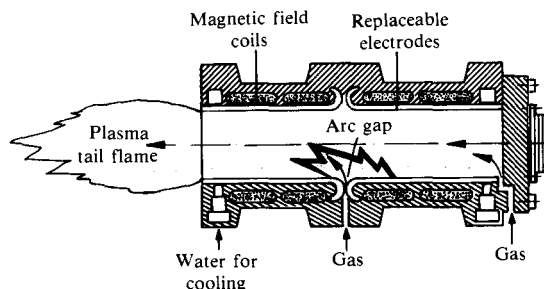

Fig. 6—A non-transferred-arc device with closely spaced electrodes (after Fey and Melilli⁸)

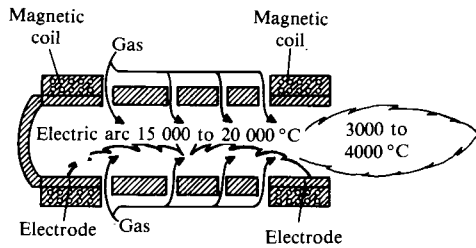

Fig. 7—A non-transferred-arc device with segmented electrodes (after Santen *et al.*⁹)

Graphite electrodes are not normally water-cooled, and can be of the rod or tubular type. Such electrodes are generally more massive than water-cooled metallic electrodes so that they can carry the higher electrical currents used. However, water-cooled graphite electrodes are now being developed.

Electrode Diameter

The diameter of rod-type electrodes depends on the current to be carried and the material of construction. Water-cooling enables electrodes of considerably smaller diameter to be used. Therefore, a thoriated tungsten electrode to carry 10 kA requires a tip size no more than about 10 mm. (The current density for thermionic emission by thoriated tungsten is about 12 kA/cm².) A graphite electrode of 200 mm diameter would be required to carry this current.

The relationship between the current and the diameter of graphite electrodes, which are not water-cooled, is not determined by the saturation current density for thermionic emission but rather by the temperature and stress profiles generated in the bulk of the electrode column by the resistive heating from the current. This depends on the electrical resistivity and thermal conductivity of the graphite. Typical current-carrying values for graphite are from 20 to 35 A/cm², depending on the quality of the material. Fig. 8 illustrates the relationship between electrode diameter and current-carrying capability for two grades of graphite and for a.c. and d.c. operation.

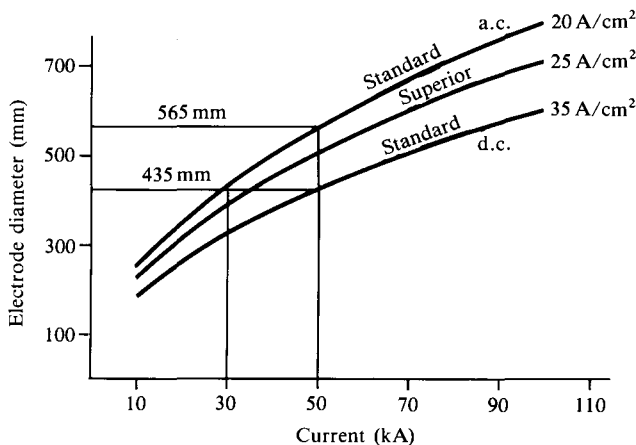

Fig. 8—The relationship between electrode diameter and current for graphite electrodes

For a current density of 20 A/cm², a 435 mm graphite electrode is required to carry 30 kA, but an electrode of the same diameter can carry 50 kA if d.c. is used rather than a.c. because of the absence of the 'skin effect'. A 565 mm electrode would be required for a.c. operation at 50 kA.

The annular diameter of water-cooled tubular electrodes is related to the gas flow, gas velocity, gas type, and the desired power level, i.e. current and voltage. Diameters vary from 50 mm for small-scale or very high-voltage devices to some 600 mm for high-current devices. Voltage is largely a function of the length of the arc and not of the diameter of the annulus. A very high-voltage device, namely the Hüls Arc Heater¹⁰, is shown in Fig. 9.

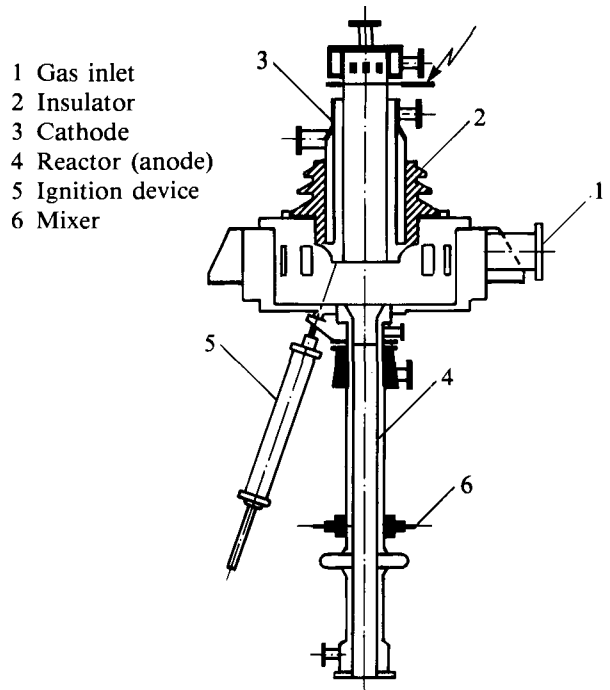

Fig. 9—A high-voltage non-transferred-arc device (after Kerker and Müller¹⁰)

Operating Characteristics of Plasma Devices

The operating characteristics depend on a number of variables, like the type of plasma device, the specifications of the power supply, the plasma gas, and the application. The characteristics fall into two areas: electrical and physical. The arc attachment for rod-type electrodes is normally concentrated in a very small region near the tip of the rod, whereas the arc attachment for the tubular-type electrode is moved rapidly over the surface of the electrode by gas-vortex or electromagnetic forces. As a result of their rather different geometrical designs, the two types of plasma devices have very different operating characteristics, and their development has followed separate paths.

Transferred-arc devices have been developed to operate at relatively high currents (10 kA) and low voltages (0.5 kV), whereas non-transferred-arc devices operate at low currents (1 to 2 kA) and high voltages (2 to 7 kV).

The electrical characteristics can be grouped as shown in Fig. 10, which shows the relationship between current and voltage¹¹. The electrical criteria for the attainment of high power levels can be noted from this figure. Power levels greater than about 7 MW in a single water-cooled device are not yet available commercially, but graphite electrodes can operate at current levels that can permit power levels of 50 MW to be reached (100 kA × 0,5 kV).

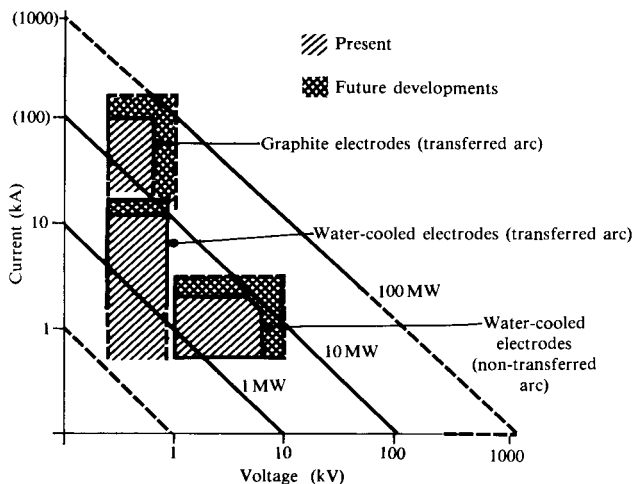

Fig. 10—Electrical operating characteristics of plasma devices (after Barcza et al.¹¹)

The water-cooling and gas-flow requirements depend on the type of device and the operational power level. In general, non-transferred-arc devices require much more water-cooling (500 m³/h) and far higher gas flowrates (1000 m³/h) than are required by transferred-arc devices (typically 4 and 6 m³/h respectively).

Physical constraints on the attainment of high power levels with water-cooled devices relate primarily to the electrode(s). The rate of electrode erosion is largely a function of current, and hence lower rates are found under conditions that allow high voltages to be attained. Electrode life, however, is more a function of the engineering design of the device and the available mass of electrode to be eroded. Fig. 11 illustrates the electrode-erosion characteristics of graphite, thoriated tungsten, and copper in transferred and non-transferred devices respectively¹¹. Electrode life can therefore vary from 100 to over 1000 hours, depending on design, current level, etc. Graphite electrodes are replaced continuously, whereas the whole electrode has to be replaced periodically in alternative systems. Operation at a high current level will shorten the life of a water-cooled device to a matter of minutes, and hence the attainment of high voltages has been a major factor, especially in the use of non-transferred-arc devices, where both electrodes are contained within the device. These devices can achieve higher voltages with long arc lengths (e.g. 7 kV for a 1 m arc length in the Hüls device) than transferred-arc devices can, and the latter type therefore needs to run at higher currents to attain similar power values. Voltage for the latter system is more a function of the interfacing of the device (which contains only one electrode), and therefore

the arc length and the process medium both play major roles.

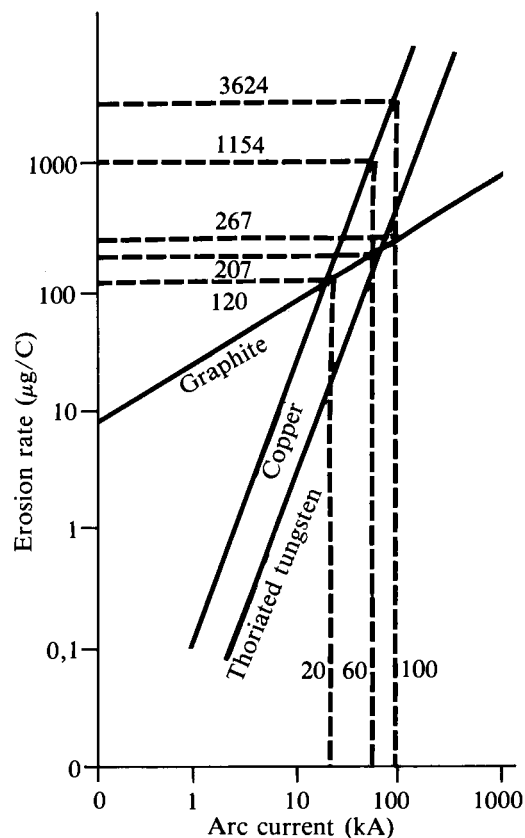

Fig. 11—Erosion in copper, graphite, and thoriated-tungsten electrodes as a function of current (after Barcza et al.¹¹)

The electrical-to-thermal efficiency of plasma devices varies from less than 50 per cent up to about 95 per cent, depending on the cooling requirements and on other operating parameters like gas type, gas flowrate, arc length, and electrical conditions, i.e. voltage, current, etc. Water-cooled transferred-arc systems are generally very efficient in themselves, but their interfacing with the process has a considerable overall effect on the furnace, i.e. on process efficiency. The cooling of the outer jacket, while negligible in air, can be large if the device is operated in a high-temperature environment like that within a furnace. Arc length has a major influence on the direct transfer of thermal energy to the bath in a transferred-arc system¹², as shown in Fig. 12. Furthermore, the design of the furnace contributes significantly to its overall efficiency, especially in open-bath configurations, where the absence of a burden results in high levels of thermal radiation from the surface of the bath to the roof and side walls of the furnace. High throughput rates are therefore necessary to offset these various mechanisms of energy loss. For these reasons the interfacing of a transferred-arc device has a major influence on the overall energy consumption of a given process.

Non-transferred-arc devices are generally inherently less efficient within themselves than are transferred-arc devices, since both electrodes normally need to be cooled. Typical values of 70 to 85 per cent have been reported

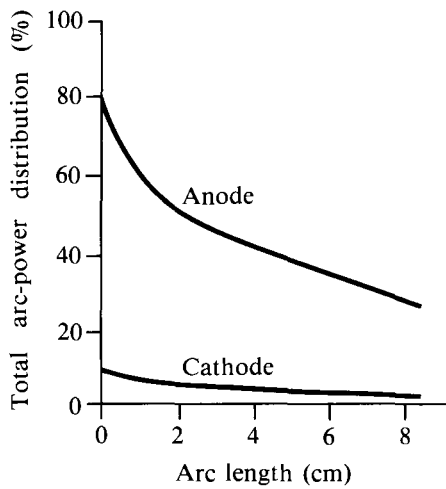

Fig. 12—Efficiency as a function of arc length for a transferred-arc system (after Choi and Gauvin¹²)

in the literature for the device itself, but the energy losses from the furnace have also to be subtracted from these values. Interfacing plays a large role too. Efficiency characteristics for the Westinghouse arc heater are given in Fig. 13, which shows that values of about 80 per cent are typical⁸. The interfacing of these non-transferred-arc devices with burden-filled shaft furnaces helps to contain the overall energy loss to some extent since there is little direct loss of energy due to radiation from the reaction zone. The off-gases are cooled to some extent as they pass upwards through the material in the shaft.

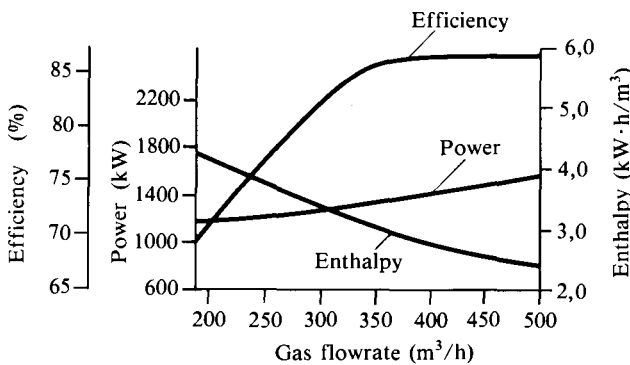

Fig. 13—Efficiency as a function of gas flow for a non-transferred-arc heater (after Fey and Melilli⁸)

INTERFACING OF PLASMA DEVICES WITH FURNACES

In general, transferred-arc devices have been interfaced with open-bath furnaces in which melting or smelting processes are carried out. Non-transferred-arc devices have been applied to shaft furnaces for direct interfacing with processes, but there are also some applications of indirect interfacing where a gas is reformed or merely superheated, i.e. only part of the gas stream passes through the plasma device, the balance being blended or reacted with the plasma-heated gas stream prior to its introduction to the shaft.

Open-bath Furnaces

Open-bath systems can be based on water-cooled metallic devices or solid graphite electrode(s) located above the bath, where the device normally comprises the cathode, and the bath comprises the anode connection, for the plasma-arc attachment. The arc length is controlled by variations in the position or inclination (or both) of the device, and the arc attachment can be kept stationary or moved over the surface of the anode or bath if a more evenly distributed input of energy is required. The arc column can be used to effect some degree of interaction with, for example, feed materials, as they traverse the open space above the bath. Particular care must be taken with the feeding of fine material if such interaction 'in flight' is to be realized. However, no energy benefits resulting from such interfacing of the feed material with transferred-arc systems have been conclusively demonstrated as yet, although noteworthy chemical reactions have been achieved. 'In-bath' melting or smelting reactions are rapid and go more readily to completion, resulting in favourable, i.e. high electrical-to-thermal, efficiencies.

Systems Based on Water-cooled Devices

Water-cooled devices can produce very stable, well-directed plasma-arc columns that can be readily transferred to an open bath. Examples of systems that were developed to interface the transferred-arc plasma column with material being fed^{7,13,14} are shown in Figs. 14 and 15.

The precessing plasma system of Tetronics Research and Development (TRD) is shown in Fig. 14. Mechanical movement of the water-cooled plasma gun is used to effect conical rotation of the arc column, which is inclined from the vertical so that the arc attachment on the bath surface describes a circle of variable diameter. High rates of precession can be used so that some of the falling feed material will interact with the 'expanded' arc column. At slower precession speeds, the energy is distributed over a larger zone on the bath surface than it is with a stationary arc column.

The Sustained Shockwave Plasma (SSP) system shown in Fig. 15 demonstrates another method by which the feed material can interact with the plasma-arc column. The arc column is rotated electromagnetically over a ring anode (not the bath). Considerable degrees of material conversion in flight, e.g. reduction, have been demonstrated on the SSP, but at low thermal efficiencies (less than 50 per cent)¹³.

The Noranda system, which is shown in Fig. 16, is being used by Davy McKee for pilot-plant work. The feed material is introduced into the reactor round the top of the arc column, which protects the side walls from radiation and pretreats the feed material to some extent. The arc is transferred to the bath, and the feed material also falls onto the bath surface. The arc column is stationary and no deliberate attempt is made to interact the feed with the plasma region itself. This system permits the use of long arcs, thereby attaining reasonably high voltages.

As yet, none of the abovementioned three systems has been developed for commercial operation at power levels greater than about 2 MW, although the TRD plasma device has attained higher power values during testing, namely about 5 MW.

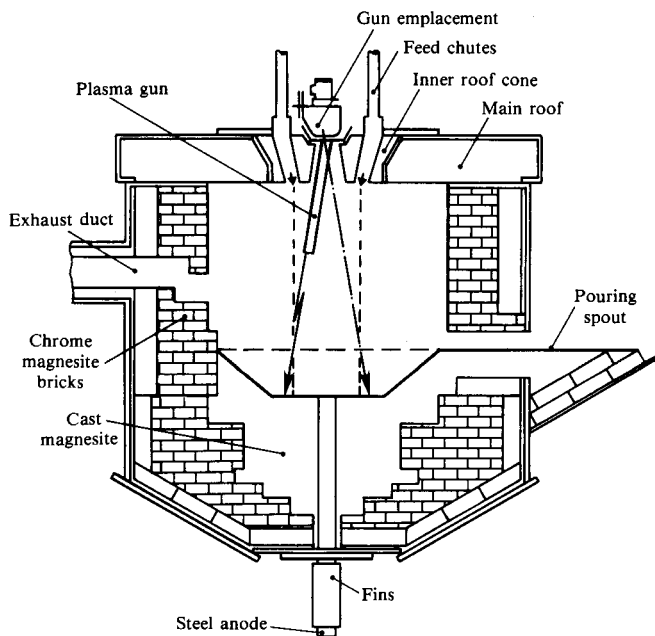

Fig. 14—An open-bath transferred-arc system with mechanical precession of the electrode so that falling feed interacts with the arc column (after Page⁷)

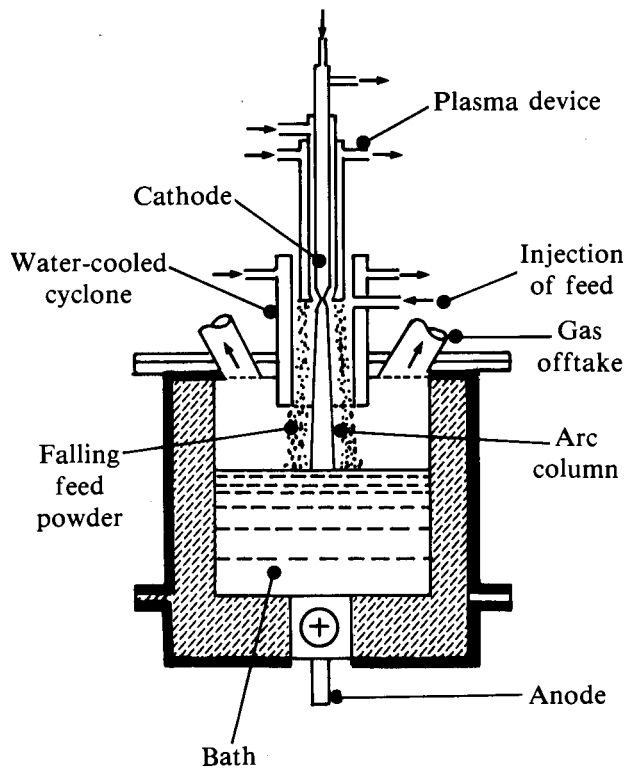

Fig. 16—An open-bath transferred-arc system with feed material surrounding the arc column (after Kershaw and Naden¹⁴)

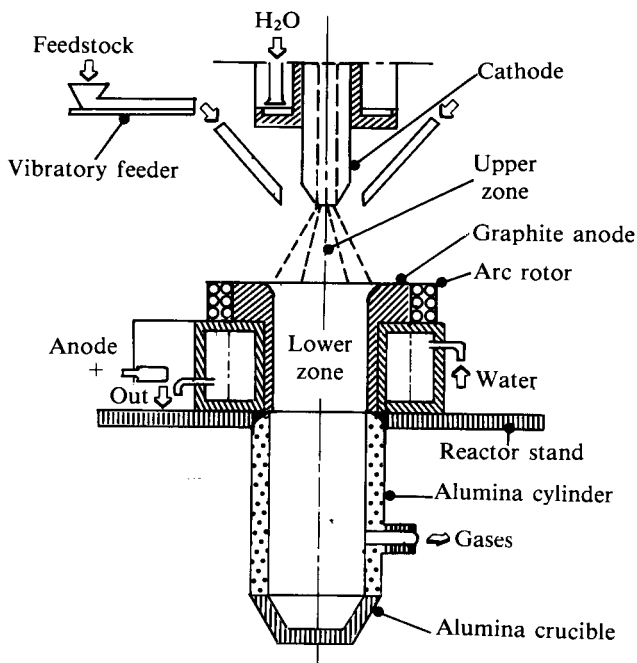

Fig. 15—An open-bath transferred-arc system with electromagnetically rotated arc to pretreat feed material 'in flight' (after Tytko *et al.*¹³)

Examples of systems for which no specific interaction of the feed material and the plasma-arc column is designed are shown in Figs. 17 and 18. The Daido system, illustrated in Fig. 17, has an induction coil located round the crucible, and the water-cooled plasma device is located vertically above the bath¹⁵. The 3,2 MVA pilot-plant furnace at Mintek is shown in Fig. 18. The electrode chosen can be either a water-cooled torch or a graphite

electrode¹⁶. The multiple plasma-device system shown in Fig. 19 is the Freital-Voest Alpine furnace for the melting of steel scrap¹⁷.

Systems Based on Graphite Electrodes

In many instances, there is no need for the sophistication of a water-cooled metallic electrode with gas support as a plasma device. A simple graphite electrode will suffice, although improved arc stability can be realized if some plasma-supporting gas is introduced down a small

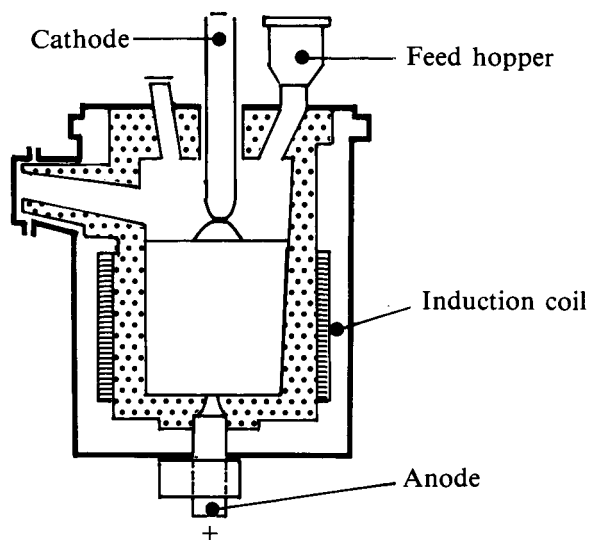
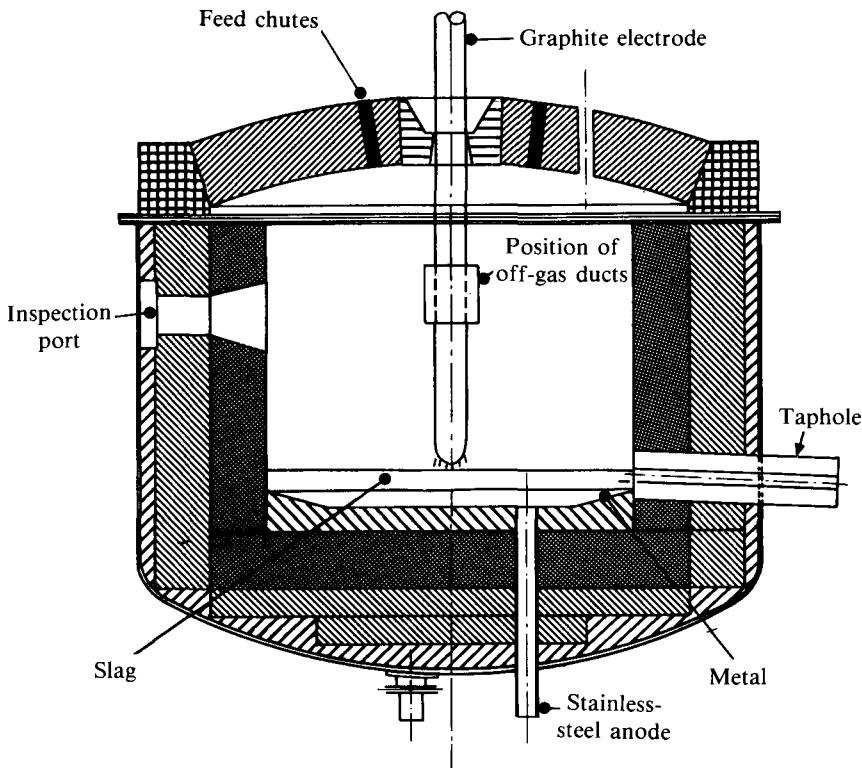









Fig. 17—An open-bath transferred-arc system with supplementary induction-coil heating (after Asada and Adachi¹⁵)



Item	Description
	Chemically bonded magnesite ramming (85% MgO)
	Chromite-magnesite brick (30% Cr ₂ O ₃)
	Tar-impregnated magnesite brick (96% MgO)
	Chemically bonded magnesite ramming (96% MgO)
	Rammed, fired, and tar-impregnated magnesite
	High-alumina castable (90% Al ₂ O ₃)
	Magnesite spinel brick (90% MgO)

1,0m

Fig. 18—An open-bath transferred-arc system with material feed into the bath (after Nunnington *et al.*¹⁶)

hole in the solid electrode and the end of the electrode is shaped to improve the directionality of the arc to the bath. Direct-current operation and a high-temperature environment improve arc stability even further. Conventional three-phase a.c. open-arc furnaces use three graphite electrodes. However, arc flare from the arc columns can cause the transferred energy to be directed to the side wall of the furnace rather than to the bath, especially when open-bath and long-arc conditions are used. The introduction of water-cooled roof and sidewall panels has considerably reduced this problem in recent years⁴, but the concept of a d.c. arc was revived recently with the development of modern electrical rectification equipment. Arc flare from a single d.c. electrode is much less of a problem than that from three electrodes supplied with a.c., since symmetrical arcing conditions can be achieved. Nevertheless, Iscor is successfully melting direct-reduced iron (DRI) in an open-bath operation in conventional ultrahigh-powered furnaces using a foaming slag to limit arc flare¹⁸.

Mintek is using the graphite electrode system in a study of a number of high-temperature processes in which a d.c. power supply creates the transferred-plasma arc. The graphite electrode can be scaled up immediately, and full-scale plants can be designed without delay, since there is no need for large-scale water-cooled devices to be awaited or for multiple devices of smaller scale, which are more expensive and complex, to be employed.

Areas of concern regarding the use of d.c. arcs in open-bath processes included stray arcing between the electrode and the water-cooled panels or refractory side walls of the furnace, excessive radiation from the bath to the roof causing refractory damage, preservation of the anode

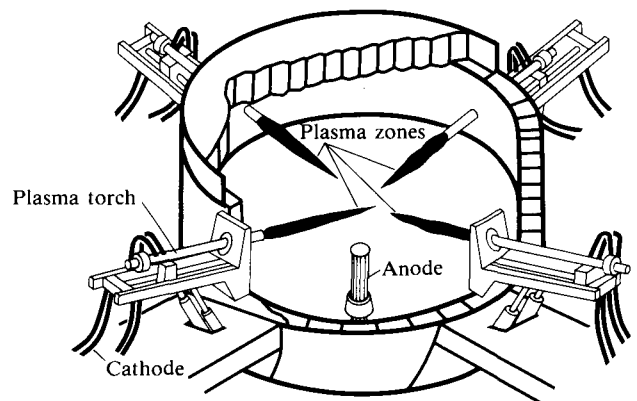

Fig. 19—An open-bath multi-torch transferred-arc system (after Freital-Voest Alpine¹⁷)

contact with the bath, loss of fine feed material with the off-gases from smelting processes, poor distribution of thermal energy to the process itself, i.e. excessive energy loss from the bath and in the off-gases, and localized superheating at the arc attachment. Many of these problems have been overcome, and developments have resulted in improved control of the feeding rate and power input¹⁶. Mintek has therefore succeeded in operating its pilot-plant facility at power levels of over 1 MW, and at electrical-to-thermal-process efficiencies of over 80 per cent. This success has inspired confidence in the development by industry of open-bath transferred-arc technology for the melting and smelting of ferrochromium and the melting of ferromanganese alloys from fines.

Scale-up Developments: Transferred-arc Systems

Production rate is determined by the commodity produced. High-value materials are produced in small quantities and therefore require small furnaces operating at lower power levels (typically 0,5 to 2 MW). The production of materials of lower value, e.g. iron, steel, stainless steels, ferro-alloys, and titania-rich slags, must be on a very much larger scale to be economic¹¹. Typical production rates are from about 10 t/h (250 t/d) to about 60 t/h. The energy consumption (thermodynamic) varies from 0,5 MW·h/t for the melting of metal scrap to between 3 and 8 MW·h/t for the smelting of ferro-alloys. Hence, the total power level required varies between about 30 and 60 MW. Power-density values of about 2 MW/m² and 1,5 MW/m² have been attained for melting and smelting respectively in open-bath tests at Mintek. Successful performance at high power density can be achieved, but only where the process chemistry is neither rate limiting nor associated with the excessive generation of volatile species (e.g. silica or manganese). This consideration can be used as a basis for the calcula-

tion of furnace diameter. Fig. 20 shows the relation between the power density and the internal diameter of a furnace. Dimensions like height and bath depth follow from the capacity requirements and arc length as determined by voltage criteria. The refractory design must ensure that the hot-face temperature does not exceed the temperature specifications of the material. Apart from this, thermal conductivity is the critical parameter. If a temperature gradient is supplied from this hot face to the outside of the furnace (air- or water-cooled), the heat (energy) loss can be determined typically in kilowatts per square metre of surface. High heat-flow values are greater than about 20 kW/m², and very high values are 100 kW/m².

The electrical-to-thermal efficiency is determined by the total heat loss from the furnace and the throughput (production) rate. Fig. 21 illustrates these relationships for a hypothetical 30 MW d.c. transferred-arc furnace.

The criteria for the scale-up of a plasma device to attain the power levels required for large-scale operation

Fig. 20—The relationship between power density and the internal diameter of a furnace

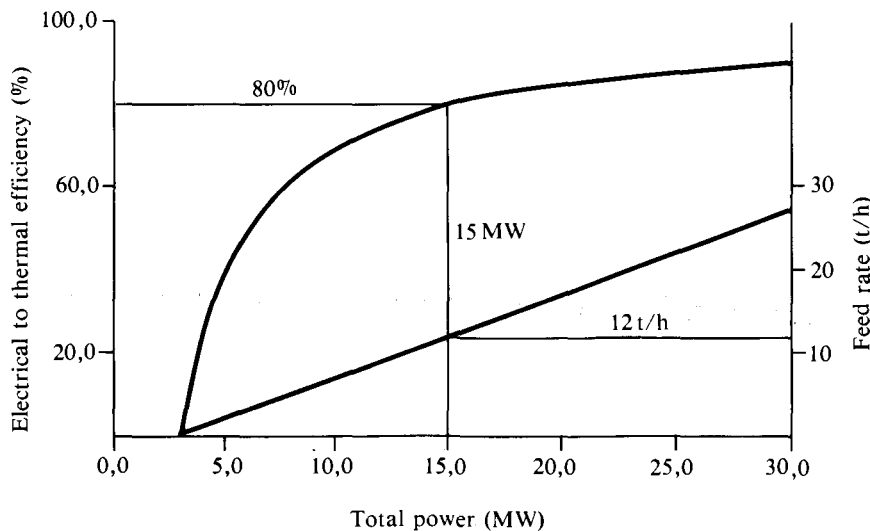
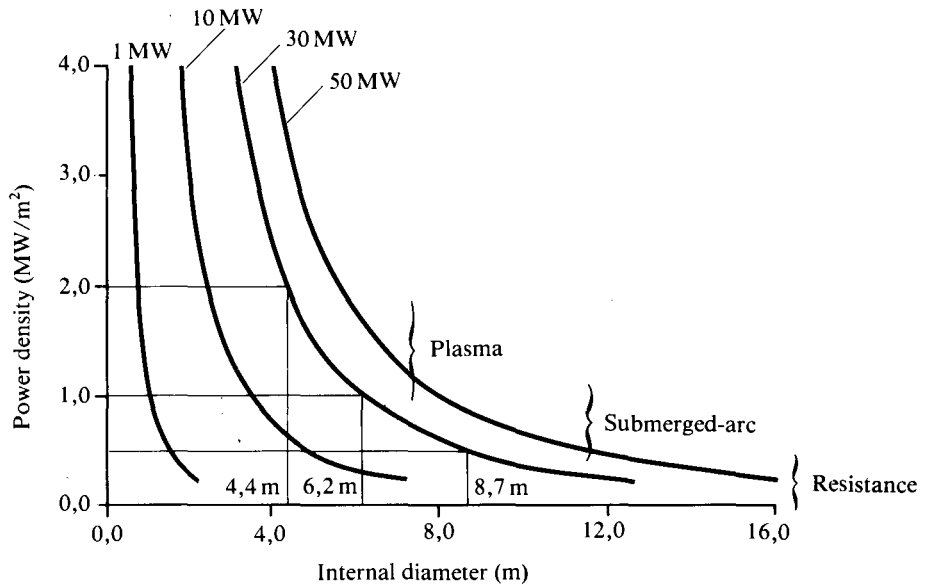

Fig. 21—Efficiency relationship for a 30 MW d.c. transferred-arc furnace

is one of the key development areas. Single water-cooled devices cannot attain such power levels, and the only option at present is the use of graphite electrodes. A 30 MW d.c. arc furnace would require an electrode of about 500 mm to operate at 60 kA. The voltage would be typically 300 to 500 V depending on arc length, and would give power levels of between about 20 and 30 MW. The calculated rate of electrode consumption at 60 kA is about 200 μg of carbon (i.e. 45 kg/h). The consumption rate per ton of product depends on the unit power consumption of the process. At 0,5 MW·h/t the rate is about 2 kg/t for d.c. operation, compared with about 4 kg/t for a three-phase open-arc furnace under optimum conditions (i.e. limited oxidation). This difference in consumption is even more noticeable for higher values of power consumption, i.e. for smelting, as shown in Fig. 22.

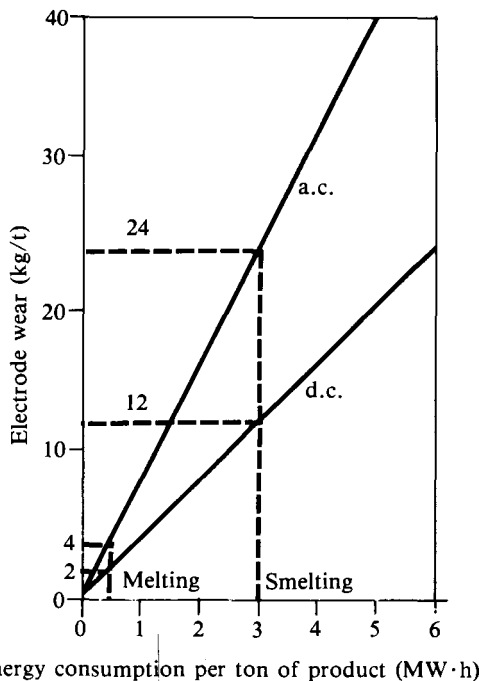

Fig. 22—Electrode wear as a function of energy consumption for a.c. and d.c. operation

Shaft Furnaces

Direct and indirect interfacing of non-transferred plasma-arc devices has been carried out for a number of high-temperature processes. Direct interfacing implies the installation of the device onto the vessel in which the pyrometallurgical process is taking place. Indirect interfacing involves the use of the non-transferred-arc device, for example, merely to reform or superheat a gas stream that is passed only subsequently through the actual main processing unit itself, normally a shaft furnace. Shaft furnaces are also used in the direct interfacing approach. The very hot 'tail flame' or superheated gas from the plasma device is introduced directly into the lower region of the packed bed of material within the shaft furnace (i.e. without being mixed with another gas stream, as it is in indirect interfacing). Horizontal or slightly inclined positions are normally preferred for the devices. Fine feed

materials are injected pneumatically into the high-temperature reaction zone created by the plasma devices.

A hollow refractory-lined vessel is normally used for gas reforming, and the plasma devices are mounted in the side walls. The tail flame is directed into the vessel, where it interacts with the process gas to be reformed with the reforming agent—normally a hydrocarbon gas or fossil fuel, e.g. coal. Steam can be added both as a coolant and as a source of hydrogen for subsequent use as a reducing agent.

Direct Interfacing

Endothermic processes like the carbothermic reduction of metal oxides can be carried out in a coke-filled shaft furnace if the superheated gases from the tail flame of a non-transferred plasma device are directed at the reaction zone or cavity that forms in the path of the materials and energy being introduced into that region⁹ (Fig. 23). Very rapid reactions take place on the reaction surface formed by the coke at the elevated temperatures attained. The products of reaction are normally carbon monoxide gas and liquid slag and metal. The hot gases emanating from both the plasma device and the reactions rise through the coke-filled shaft furnace and leave the vessel at the top. The coke is fairly conductive thermally, and the surface of the coke can reach temperatures up to 1200 to 1400°C since no endothermic reactions take place in the upper part of the shaft or near the surface. The gas therefore can have a high content of sensible energy, as well as considerable chemical potential, and could, if economically justified, be used for pretreatment, i.e. for the preheating or possibly even prereluction of certain oxide feed materials such as fine ores (thereby effecting a saving in electrical energy in the smelting stage of the shaft furnace).

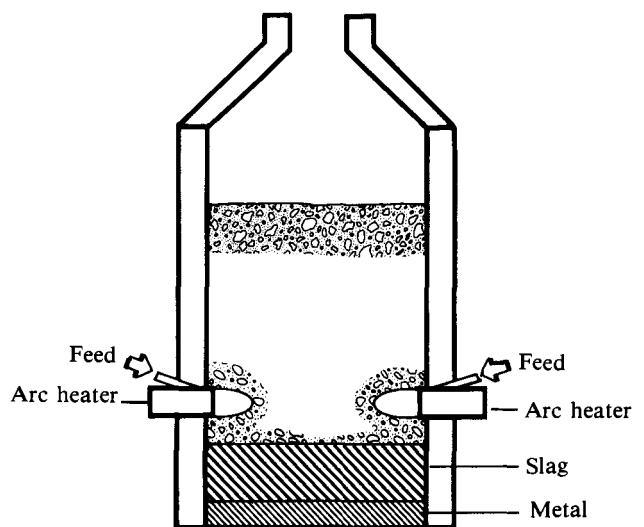

Fig. 23—A coke-filled low-shaft furnace with non-transferred plasma-arc devices (after Santen *et al.*⁹)

The coke in the shaft is essentially a refractory shield or cover for the plasma tail flame and surface of the bath of the process, and also permits the product gas to escape while restricting the loss of volatile species. The bulk of the carbonaceous reducing agent (e.g. coal fines) for the

smelting process is, in fact, fed with the optionally pre-reduced feed into the lower part of the shaft. The ratio of the fine reducing agent to coke is about 5, and the overall consumption is much lower than in a blast furnace.

Indirect Interfacing: Superheated Blast

The energy for the conventional blast-furnace process is not generated by an electrical source as it is for the submerged-arc furnace, but is generated solely by combustion of the expensive metallurgical-grade coke that is fed into the top of this tall-shaft furnace. More recently, a portion of this coke has sometimes been replaced with less costly coal fines. The coal fines are introduced through the tuyère area in the side wall near the base of the shaft. The air blast (sometimes enriched with oxygen) to combust the coke in the base of the shaft is heated by hot-blast stoves (or recuperators), the off-gas from the top of the blast furnace being used to heat the stoves in a reverse-cycle method. The enthalpy of the hot gas at some 600 to 800°C is rather low, and its effect on the rate of the coke usage (up to about 600 kg per ton of metal, i.e. pig iron) is limited, 400 kg/t being the best value attainable conventionally.

A non-transferred plasma-arc device can be used to superheat the gas to be injected through the tuyères to temperatures up to, or possibly even well over, 2000°C. Furthermore, reducing gases can be used to effect a further decrease in the rate of coke consumption to a theoretical minimum¹⁹ of some 80 kg/t.

The arc-heater device is not directed into the base of the blast furnace itself but into the gas stream prior to its entry through the tuyère⁸, as shown in Fig. 24.

Indirect Interfacing: Gas Reactors

Non-transferred plasma-arc devices can be used to process, i.e. reform or produce, gases for the chemical and metallurgical industries. The reforming of methane (CH₄) with water in the form of steam or carbon dioxide from a recycled gas stream in a process like the reduction of a metallic oxide requires thermal energy. This energy is more conventionally provided indirectly via a heat-exchange method through reformer tubes.

Fig. 25 illustrates a reforming vessel with two plasma devices. The hot gas from the reformer is used to reduce iron oxide ore in a shaft furnace²⁰.

Scale-up Developments: Non-transferred-arc Systems

A single non-transferred-arc heater device can reach power levels of only about 8 MW since operation at currents much greater than about 2 to 3 kA would lead to

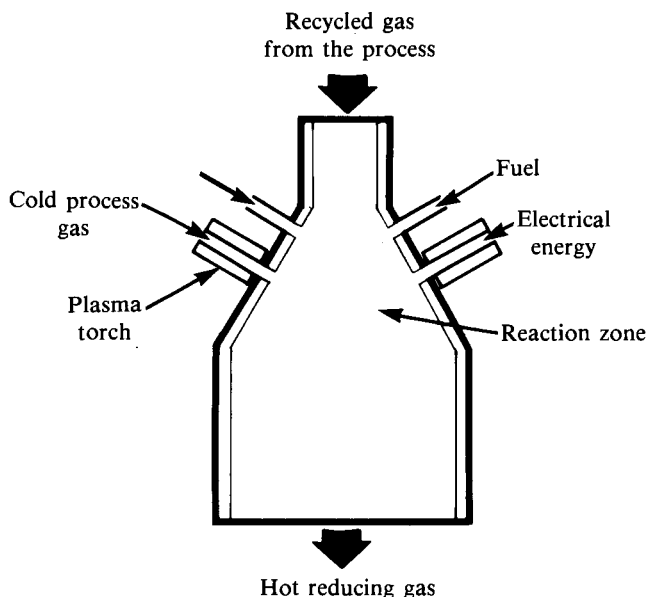

Fig. 25—An SKF reformer vessel with non-transferred-arc devices (after SKF Steel Engineering AB²⁰)

excessive electrode wear and very short electrode life. The use of multiple devices is therefore necessary in large-scale applications. Typically, a plant to process some 75 kt of preheated chromium ore per year (at 3 MW·h/t) would require four 8 MW non-transferred-arc heaters if the overall loss of power were about 5 MW (3,2 MW for the four devices and 1,8 MW for the shaft furnace). The rate of electrode erosion would be about 0,035 kg of copper per ton of metal. Electrode lives of between 100 and 200 hours could be expected if the wear over the electrode length were reasonably even. Gas flowrates of about 1000 Nm³ per device would be needed, not only to permit operation at suitable voltage and current levels but to convey the energy to the process via the high-enthalpy gas (2 to 4 kW·h/Nm³). Some of the process gas would be recycled to the plasma device after being cooled and cleaned. Cooling-water requirements would necessitate substantial heat-exchange capacity unless alternative uses could be made of this low-enthalpy source.

The development of devices with power ratings much greater than 10 MW and with reasonable electrode lives does not seem likely in the short term, but the technology has the potential to reach very high power levels. The optimum power level would probably be about 10 MW, since four to six such devices will give a furnace rating equivalent to that of the largest conventional electric-smelting furnaces (although well below the equivalent

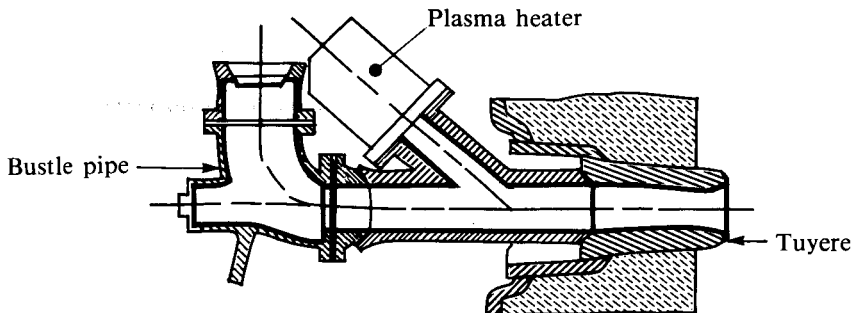

Fig. 24—A non-transferred-arc device attached to a tuyère of a blast furnace (after Fey and Melilli⁸)

rating of a large blast furnace, where its role would probably have to be more supplementary).

Arc heaters rated at some 6 to 7 MW are suitable for gas reforming on DRI plants, and scale-up to much greater power levels is probably unnecessary since multiple devices can also be used in this instance.

EXAMPLES OF LARGE-SCALE APPLICATIONS

Direct Reduction of Iron

Direct reduction of iron ore in the form of lumpy material or of fines agglomerated as pellets can be carried out in a vertical shaft furnace or a rotary kiln.

The former method uses gaseous reducing agents, namely carbon monoxide and hydrogen, which are introduced to the base of the shaft furnace at elevated temperatures up to 1000°C. The reducing gas is produced by the reforming of natural gas, which consists mostly of methane (CH₄), in a catalytic-reformer vessel. The endothermic reforming reactions are supported by the heating of the reformer vessel by a heat-exchanger in which some of the natural gas is combusted to provide the energy source. A recent alternative to this reforming method uses thermal plasma to heat the gases directly in the reaction vessel. Thus, the combustion of natural gas to heat the reformer indirectly can be replaced effectively with direct plasma heating inside the vessel, i.e. electrical energy. However, the plasma device is not directly coupled to the shaft furnace in which the iron ore or pellets are reduced to sponge iron, and hence the plasma is interfaced only indirectly with the process itself.

SKF Plasmared Process

This process is based on the recycling of off-gas from a shaft furnace and contains carbon dioxide and water vapour (only partial removal of carbon dioxide and water), i.e. the gas composition is 18 per cent carbon dioxide, 25 per cent carbon monoxide, 22 per cent water, and 35 per cent hydrogen. Not all the gas enters the reformer vessel directly, about 20 per cent being cleaned, compressed, and injected through the 6 MW arc-heater device to reach a temperature of some 3000 to 4000°C. The reforming agents, which were rated by SKF on their demonstration-scale industrial plant in Hofors at 70 kt/a, include liquid petroleum gas (LPG) and coal slurries²⁰. The carbon dioxide values are reduced typically to between 2 and 3 per cent by reforming. Developments that could use coal rather than gas would be of significance to countries without natural gas.

The USCO-Hüls Process

This process, which is based on the reforming of a synthetic gas produced by the gasification of bituminous coal, was installed in South Africa recently. Alternative reforming agents like coal fines are to be considered at a later stage. Steam is introduced into the reforming vessel to improve the ratio of hydrogen to carbon dioxide, and the energy for the reaction is provided by three 8 MW Hüls arc-heater devices. The process off-gas is not recycled back to the reformer vessel but is blended after the water and carbon dioxide have been removed with the superhot stream of gas produced in the reformer vessel by the interaction between the high-temperature plasma tail flame, the syngas, and the steam. Three

reformer vessels, each having an arc heater rated at some 8 MW (i.e. three heaters, 24 MW in all), are to be used. The production capacity of the shaft furnace is expected to be some 300 kt of DRI per year²¹.

Production of Pig Iron

CRM/Cockerill Steel-Westinghouse

The conventional blast furnace for the production of pig iron is operated only with chemical energy derived from the combustion of relatively expensive coke in the tuyère region. The coke is combusted by the injection of a blast of hot air. The rate of coke consumption is normally 400 to 600 kg/t, but the use of electrical energy can lower the rate to less than 200 kg/t. Testwork on an experimental blast-furnace pilot plant was carried out by CRM in Belgium, and subsequent work was done on an industrial-scale blast furnace at Cockerill Sambre Co. in Belgium using a single Westinghouse arc heater rated at 3,5 MW. Air and natural gas have been heated with the plasma device so that the decrease in coke consumption can be evaluated on this industrial scale. The performance so far has been reasonably satisfactory, and further developments are awaited from testwork in Europe and the U.S.A.

Westinghouse in the U.S.A. have compared a proposed 'Plasmasmelt' (i.e. SKF) process to produce some 250 kt of iron per year with a 2 Mt/a blast furnace⁸. The former route was projected to produce iron at 144 U.S. dollars per ton, and the latter at 178 U.S. dollars per ton. The production rate of 32 t/h by the Plasmasmelt route would require seven 6 MW arc heaters (85 per cent efficiency). The Plasmasmelt route is discussed below.

SKF Plasmasmelt

The Plasmasmelt route is based on the direct use of iron oxide ore fines. These ore fines are dried, preheated, and prereduced in fluidized-bed reactors to some 60 to 70 per cent metallization, and then injected directly into the lower region of a coke-filled shaft furnace. Thermal energy is supplied by arc-heater devices located in what would be the tuyère region of a blast furnace. The prereduced ore fines and plasma tail flame interact directly on the coke layer in the base of the shaft furnace. Coal fines and fluxing agents are added with the prereduced feed to complete the smelting process. Coke consumption is minimal at about 50 kg per ton of pig iron. The optimum relationship between the degree of prereduction and the generation of the required process gas for prereduction from the smelting stage can be achieved by the balancing of the coal-to-oxygen ratio (tuyères) and the input of electrical energy (plasma device). Fig. 26 illustrates the Plasmasmelt process route⁹.

Proposals for an industrial plant were made a few years ago in Sweden, but the investigation was only a paper study. The emphasis changed recently from pig iron to the processing of steel-plant dust, and the process has been named Plasmadust.

ASEA-Elred

This process, like the SKF Plasmared route, has been tested only on a small-scale pilot plant producing 12 t/d, but it also has the potential for scale-up to large industrial-scale operation. Fig. 27 shows the furnace arrange-

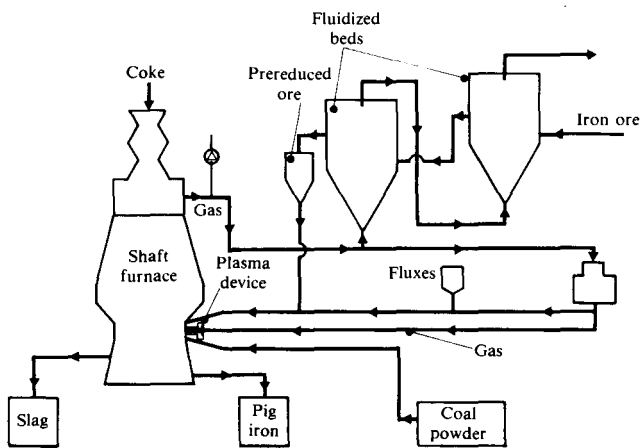

Fig. 26—The SKF Plasmasmelt Process (after Santen *et al.*⁹)

ment, which consists of an open-bath d.c. transferred-arc furnace in which the cathode is a hollow graphite electrode and the anode connection is made to the bath itself. Prereduced ore fines metallized to about 60 per cent are fed hot (700°C) to the furnace via the hollow electrode. The process produces surplus gas that could be used for other purposes, e.g. the generation of electricity²².

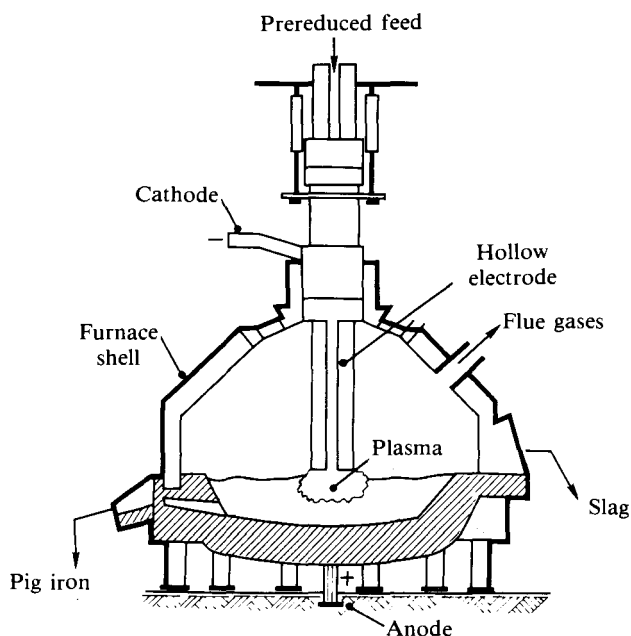

Fig. 27—The d.c. arc furnace for the Elred Process (after Bengtsson and Widell²²)

Steelmaking

Freital-Voest Alpine

The development of fairly large water-cooled transferred-arc devices or plasmatrons by the Edelstahlwerke, Freital, in the German Democratic Republic, resulted in the installation in the mid-1970s of two plasma furnaces of 15 and 35 t to melt steel scrap³. Some 600 kt of alloyed steel have been processed. The furnace design is an open bath into which scrap of a relatively high bulk

density is placed, since the electrodes or plasma devices, which are inclined towards the centre of the furnace, are located in the side walls of the furnace.

Voest-Alpine in Austria recently installed a 45 t furnace based on four water-cooled plasma devices to melt steel scrap. Table I gives details of this plant²³.

The problems encountered so far include stray arcing, refractory wear, and down-time due to adjustments to the new technology. The prospects for improved performance over those of conventional open-arc scrap-melting furnaces seem very good, since power consumptions as low as 440 kW·h/t have been achieved.

ASEA-Krupp

ASEA-Krupp have a cooperative agreement to develop large-scale d.c. arc furnaces for the melting of steel scrap. The motivation for the single d.c. transferred-arc graphite-electrode system stems primarily from the projected reduction in electrode wear. Other considerations are a more even temperature distribution, especially to the walls of the furnace; good energy transfer as a result of the stirring caused by the current through the bath to the anode connection; and less electrical and acoustic noise²⁴.

The first large-scale (55 t) industrial unit was installed as a conversion on the 18 MVA furnace melting stainless-steel scrap at Avesta in Sweden. Considerable reduction in electrode wear resulted, namely 4,75 to 2,1 kg/t. Table I gives more details of the furnace.

The large voltage drop across an a.c. reactance at higher currents limits the arc voltage on conventional furnaces but not on d.c. furnaces; hence, longer arcs with higher voltages can be used in the latter, especially where a centralized single electrode and a foaming slag help to reduce arc flare.

M.A.N. GHH

M.A.N. GHH have also started evaluating the use of d.c. arc furnaces for the melting of steel scrap. Potential scale-up to a 700 mm electrode at 34,6 A/cm² will give 133 kA and over 60 MW of melting power, capable of melting heats of some 100 to 120 t. The characteristics of the demonstration-scale d.c. arc facility installed by GHH in Sterkrade, Oberhausen²⁵, are given in Table I.

Electrode-consumption rates as low as 1,7 to 1,8 kg/t have been achieved during tests on this relatively small demonstration-scale industrial unit; larger-scale units are expected to follow when the steel market improves.

Processing of Ferrochromium

MS&A-ASEA-Mintek

Extensive pilot-plant work in transferred-arc configurations, in which water-cooled devices were used initially but graphite electrodes were used subsequently, led to the decision by Middelburg Steel & Alloys (MS&A) to install a 16 MVA furnace of semi-industrial scale to produce ferrochromium alloys. The original pilot-plant work was carried out up to power levels of about 750 kW at Tetricons Research & Development Ltd in the U.K., and was followed by numerous campaigns at Mintek. Each of these lasted many days, and was conducted at power levels just greater than a megawatt on Mintek's 3,2 MVA d.c. plasma-arc facility.

TABLE I
DETAILS OF LARGE-SCALE APPLICATIONS OF PLASMA SYSTEMS

Commodity	Company	Process type	Device	Process name or contractor	Scale (production capacity)
<i>Iron and steel</i>					
1. DRI	SKF Eng., Sweden	Indirect non-transferred gas reformer-shaft furnace—LPG or coal slurry	Plasmatech arc heater 1 × 6 MW	Plasmared Process	70 kt/a
2. DRI	USCO, South Africa	Indirect non-transferred gas reformer-shaft furnace—syngas	Hüls arc heaters 3 × 8 MW	Fluor/Davy McKee	320 kt/a
3. Pig iron	Cockerill Steel-CRM and a U.S. steel producer	Indirect non-transferred superheating of gas blast to blast furnace	Westinghouse arc 1 × 3 MW	Pyrogas Process	Industrial blast furnace
4. Pig iron (alloyed with Cr, Mn, and others)	SKF Eng., Landskrona, Sweden	Smelting in a coke-filled shaft furnace—Zn, Sn fume produced	Plasmatech arc heaters 3 × 6 MW (7 × 6 MW)	Plasmadust (SCANDUST) (Plasmasmelt)	70 kt/a (250 kt/a) paper study only
5. Pig iron	ASEA, Sweden	d.c. transferred-arc open bath	Hollow graphite electrode 40 MW	Elred Process	(600 kt/a) paper study only
6. Steel	M.A.N. GHH, Germany	d.c. transferred-arc open-bath scrap melting	Solid graphite electrode 6 MW	Unarc Process	15 t furnace
7. Steel	Freital-Voest Alpine, GDR and Austria	d.c. transferred-arc open-bath scrap melting	Water-cooled plasmatrons 3 × 7 MW 4 × 7 MW	Freital	35 t 45 t
8. Stainless steel	ASEA-Krupp	d.c. transferred-arc open-bath scrap melting	Solid graphite electrode 18 MVA	SE Process (single electrode)	55 t
<i>Ferro-alloys</i>					
1. Ferro-chromium	MS&A (Mintek-ASEA)	d.c. transferred-arc open-bath co-melting and smelting	Hollow graphite electrode 16 MVA	d.c. Chrome Process	50 or 20 kt/a*
2. Ferro-chromium	SKF Eng., Malmo, Sweden	Direct non-transferred shaft furnace (coke-filled)—preheated ore feed	Plasmatech arc heaters 4 × 6 MW	Plasmachrome	78 kt/a
3. Ferro-manganese	Samancor	d.c. transferred-arc open-bath melting	Freital-Voest Alpine plasmatron 10,8 MVA (8 MW)	Freital-Voest Alpine	50 kt/a

G.D.R. German Democratic Republic

* 50 kt/a Melting and smelting 2:1
20 kt/a Smelting

The design of the 16 MVA furnace was based on the ASEA d.c. arc furnace developed for the Elred process (discussed earlier), but was modified to some extent in the light of the experience gained in the pilot-plant work at Mintek, and at Mefos and Domnavert in Sweden. The furnace, which is shown schematically in Fig. 28, uses a single hollow graphite electrode as the cathode and a distributed anode in the hearth, which makes contact with the bath. The roof is water-cooled, but the side walls are refractory-lined²⁶.

Patents held jointly by Mintek and MS&A cover the smelting of chromite (including the co-melting of metal fines) and the refining of high-carbon ferrochromium containing 7 to 8 per cent carbon and some 3 to 5 per cent silicon to medium-carbon ferrochromium containing 3 to 4 per cent carbon and less than 1 per cent silicon^{27,28}.

The MS&A furnace has been in operation since the end of 1983 and has produced many thousands of tons of ferrochromium. The d.c. arc furnace process therefore has been virtually scaled up to an industrial operating level and from all accounts now works well after initial operating difficulties, which were mostly peripheral. The latest performance factors like efficiency and recoveries have not been disclosed, but there are indications that satisfactory operation has been achieved.

SKF Steel Plasmachrome Process

Following pilot-plant work at the 1,5 MW level using a coke-filled shaft furnace with an arc-heater device, SKF proposed several processes, including the smelting of chromite fines, to produce ferrochromium alloys. Although no plants have been built on an industrial scale for the Plasmasmelt (iron) process, a plant to process

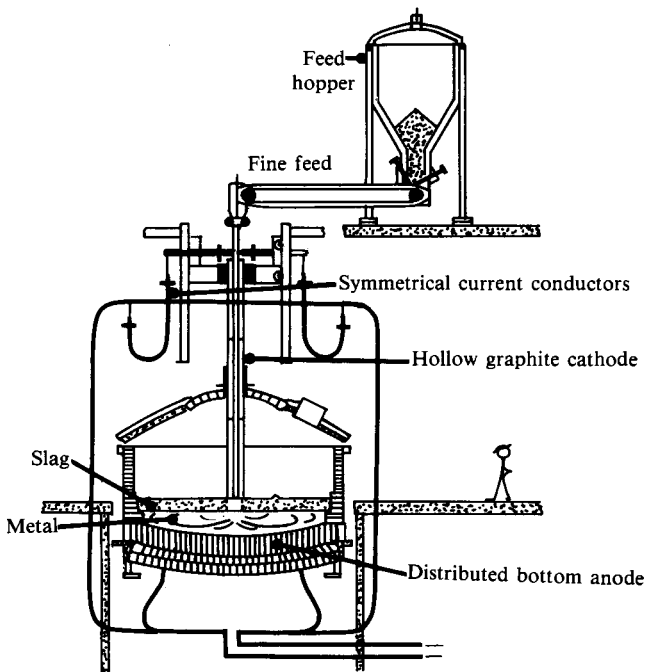

Fig. 28—A d.c. arc furnace for the production of ferrochromium (after Stickler²⁸)

about 70 kt of steel-plant dust per year (Plasmadust) has been installed at Landskrona in Sweden²⁹. Metal like zinc, tin, and iron (or iron-containing chromium, nickel, and molybdenum) will be produced. The process is apparently justified to a large degree by its elimination of an environmental problem (the dust). The products, in particular the tapped metal, are not to standard specification. However, the plant will also be used in demonstration-scale tests on the Plasmachrome process (as well as other processes, e.g. for ferromanganese and ferrosilicon).

A plant to produce some 78 kt of ferrochromium per year by the SKF process is being built near Malmo in Sweden³⁰. Table I gives the main features of the plant.

Processing of Ferromanganese

The Samancor plant, Metalloys, has installed a single water-cooled plasmatron, designed by Freital and supplied by Voest-Alpine, in a furnace designed primarily to melt ferromanganese metal fines³¹. The rating³ of the thyristor-controlled power supply is 10,8 MVA, and the plasma device itself is capable of operating up to 9 kA and 800 V, although voltages above 200 to 300 V are not realized easily in practice. Power levels of only some 2 to 4 MW are therefore obtainable unless higher voltages can be reached. At those power levels, the electrical-to-thermal efficiency would be expected to be fairly low.

Mintek has carried out a considerable amount of work on the melting and smelting of ferromanganese alloys in open-bath transferred-arc systems³². If the power density for melting is matched to the furnace size, efficient operation with good recoveries can be achieved. However, smelting results in excessive losses of manganese vapour, and a shaft-furnace approach would appear to be a more suitable configuration.

FUTURE DEVELOPMENTS

Thermal-plasma technology is on the threshold of major potential development, and the scale-up of plasma devices has reached the stage where large-scale applications are a reality. However, water-cooled transferred-arc devices are somewhat limited in power (about 5 MW) because of the relatively low voltages (300 to 500 V) that can be attained in open-bath furnaces, where very long arcs are undesirable, and because only relatively low levels of current can be carried. Graphite electrodes can overcome the restriction of current, and power levels of 30 to 50 MW seem feasible even with one electrode if d.c. is used. Multiple water-cooled devices are capable of attaining similar power levels, but the capital costs are much higher. Costs due to electrode wear are lower for water-cooled systems, but expensive gases are needed for transferred-arc devices. However, cooling is a relatively minor cost except where excessive losses of expensive electrical energy are incurred. Insulation of the device can reduce such losses. Graphite electrodes, while costly, are convenient. Wear rates as low as 1,5 kg per ton of steel, i.e. 3 kg/MW·h are currently being realized in d.c. arc operation²⁵. Water-cooled transferred-arc devices have been used on large-scale furnaces, but some further developmental work is needed if they are to compete with graphite electrodes³³.

At one time, open-bath furnaces were considered suitable only for the melting of steel scrap, but the smelting of certain oxide materials, and presumably sulphide materials, is feasible and also economic, provided good throughput and high availability can be maintained. High power densities, balanced feed and power inputs, optimum distribution of feed and power (e.g. injection and stirring), good refractory design, and reliable performance of the plasma device and the anode contact all favour satisfactory operation. Fine materials can be processed to give good recoveries, and this approach, once the performance and reliability of the equipment have been demonstrated, is therefore likely to be favoured over that using the submerged-arc furnace.

Non-transferred-arc devices have also attained reasonable scale-up to the 6 to 8 MW power level, and high-voltage operation, which is inherent in such devices, has enabled lower currents to be used. Furthermore, a larger electrode surface is available for arc attachment than in the transferred-arc device. This can result in considerable electrode life, especially for the very-high-voltage, low-current devices. Nevertheless, multiple systems are still necessary to accommodate large-scale applications, and this can be costly from a capital point of view. Non-transferred-arc devices require very high volumes of gas (1000 Nm³/h) but, since process gas can be recycled and utilized after cooling and cleaning, the cost is relatively small. The cooling requirements are large, and represent a considerable loss of electrical energy. There is room for improvement in the electrical-to-thermal efficiency of such devices, but 90 per cent seems a realistic target that has already been met under some circumstances. It should be possible for the lengthy down-time needed for the replacement of electrodes to be decreased with improved engineering design and, since the electrode material itself is relatively cheap, there appears to be no competition from graphite as there is for transferred-arc systems.

Shaft furnaces are especially suitable for the processing of materials that have volatile species, e.g. silicon monoxide or manganese, or where the shaft is used to prereducer oxides that are amenable to gas-solid reactions. The combustion of coal fines combined with electrical energy as the source of thermal energy appears feasible, and this probably provides the best answer as to how one can reduce the usage of expensive coke and replace electrical energy to some extent in the smelting of the more-refractory oxide minerals.

However, it is probably in the treatment of light and refractory metals that plasma technology will achieve its greatest development in years to come. The production of alloys of aluminium, magnesium, and titanium is costly by conventional methods, despite the relative abundance of these metals in the earth's crust. The energy requirements for the production of the metals are high, and very low oxygen potentials are necessary. These are factors that favour thermal plasma. Much developmental work is still needed in this interesting field. It should be remembered that electrically generated thermal energy is a unique temperature source that, in many instances, cannot be replaced technically or economically by the combustion of a fuel.

ACKNOWLEDGEMENTS

This paper is published by permission of the Council for Mineral Technology. Thanks are due to Mr T.R. Curr and Dr K.U. Maske for helpful suggestions.

REFERENCES

1. ANON. Middelburg strives to stay ahead in charge chrome. *Metal Bulletin Monthly*, Jul. 1983. pp. 91-93.
2. HERLITZ, H.G., JOHANSSON, B., and SANTEN, S. A new family of reduction processes based on plasma technology. *Iron and Steel Engineer*, vol. 61, no. 3. Mar. 1983. pp. 39-44.
3. ANON. Voest Alpine's plasma plant. *Metal Bulletin Monthly*, Jun. 1983. pp. 45-49.
4. STROHMEIER, B. Increasing productivity by implementing advanced technologies at Iscor's large UHP-arc furnace shop. *Journal of Iron and Steelmaker*, vol. 12, no. 5. May 1985. pp. 43-49.
5. BARCZA, N.A., FEATHERSTONE, R.A., and FINN, C.W.P. Recent developments in the ferro-alloy field in South Africa. *Proceedings, Twelfth Congress of the Council of Mining and Metallurgical Institutions. Glen, H.W. (ed.)*. Johannesburg, The South African Institute of Mining and Metallurgy, 1982. vol. 2. pp. 595-603.
6. BARCZA, N.A., and STEWART, A.B. The potential of plasma-arc technology for the production of ferro-alloys. Preprint, INFACON '83, Tokyo. 24 pp.
7. PAGE, D. Some of Tetratics' contributions and achievements in respect of plasma developments. Faringdon, U.K., Tetratics R & D Ltd, Jan. 1985. 3 pp. (Private communication.)
8. FEY, M.G., and MELILLI, W.J. The application of thermal plasma systems to economical ironmaking. Paper presented at the 5th International Symposium on Plasma Chemistry, Edinburgh, Aug. 1981. 20 pp.
9. SANTEN, S., HERLITZ, H., FLINK, B., and SKOGBERG, J. Industrial processes based on plasma technology. *MINTEK 50. Haughton, L.F. (ed.)*. Randburg (Transvaal), Council for Mineral Technology, 1985. vol. 2, pp. 837-846.
10. KERKER, L., and MÜLLER, R. The plasma reforming process from Chemische Werke, Hüls AG for the production of reduction gases. Paper presented at the 23rd CIM Annual Conference of Metallurgists, Quebec, Aug. 1984. Paper 14. 12 pp.
11. BARCZA, N.A., CURR, T.R., and MASKE, K.U. The application of thermal plasma technology to large-scale pyrometallurgical processes. Preprints, Extraction Metallurgy '85. London, Institution of Mining and Metallurgy, 1985. 30 pp.
12. CHOI, H.K., and GAUVIN, W.H. Operating characteristics and energy distribution in transferred plasma arc systems. *Plasma Chemistry and Plasma Processing*, vol. 2, no. 4. 1982. pp. 361-385.
13. TYLKO, J.K., MOORE, J.J., and REID, K.J. Extraction of metals in the new sustained shockwave plasma (SSP) reactor. Preprints, Extraction Metallurgy '81. London, Institution of Mining and Metallurgy, 1981. pp. 234-256.
14. KERSHAW, P., and NADEN, D. The development of integrated ore pre-reduction and d.c. transferred arc plasma smelting technology for iron and ferro-alloys production. *PROCEEDINGS ISPC7. Timmermans, C.J. (ed.)*. Jul. 1985. vol. 4. pp. 1208-1213.
15. ASADA, C., and ADACHI, T. Plasma induction melting. *Neue Hütte*, vol. 15, no. 11. pp. 657-660. (BISI 20029. Jul. 1981. 9 pp.)
16. NUNNINGTON, R.C., MASKE, K.U., SCHOUKENS, A.F.S., CURR, T.R., and BARCZA, N.A. Developments in refractories for plasma technology. Presented at the Institute of Refractory Engineers' Bi-ennial Colloquium, 6th Mar., 1985. Pretoria, Council for Scientific and Industrial Research, 1985. 38 pp.
17. ANON. Voest Alpine's plasma plant. *Metal Bulletin Monthly*, Jun. 1983. pp. 45-49.
18. STROHMEIER, B., and BACHMAYER, J. Melting of kiln-based DRI in large UHP-arc furnaces at Iscor Ltd. Paper presented at the 5th SL/RN Kiln Operators' Conference at Vanderbijlpark, South Africa, 21st to 24th Apr., 1985. 20 pp.
19. PONGHIS, N., VIDAL, R., and POOS, A. Pirogas—a new process allowing diversification of energy sources for blast furnace. *High temperature technology*, vol. 1, no. 5. Aug. 1983. pp. 276-281.
20. SKF STEEL ENGINEERING AB. Plasmared for direct reduction of iron ore. Hofors (Sweden), SKF, *Brochure* 1983. 6 pp.
21. MANLEY, J. South African steel going its own way. *Metal Bulletin Monthly*, May 1984. pp. 13-34.
22. BENGTTSSON, E., and WIDELL, B. The chemistry of the Elred Process. *Iron and Steelmaker*, vol. 8, no. 10. 1981. pp. 30-34.
23. KNOPPEK, T., LUGSCHIDER, W., and STEIPE, O. Initial results of Voest Alpine 45 t plasma furnace and future aspects of plasma technology. Paper presented at Metek 84, Dusseldorf, Jul. 1984. 29 pp.
24. KUNZE, H.G. Design and operational experience of a 55-t direct current arc furnace. Paper presented at Metek 84, Dusseldorf, Jul. 1985. 25 pp.
25. ESSMANN, H., GRÜNDBERG, D., and HILGENSTOCK, H. Technical and economic considerations concerning the use of d.c. arc furnaces. *MPT*, vol. no. 1. 1984. pp. 24-32.
26. STICKLER, H. Variations of the Elred Process. *Stahl u-Eisen*, vol. 104, no. 11. 1984. pp. 539-541. (In German.)
27. CURR, T.R., and BARCZA, N.A. The production and treatment of ferrochromium. *S.Afr. Pat. 82/7404*. Assignees: The Council for Mineral Technology and Middelburg Steel & Alloys. Aug. 1983. 30 pp.
28. CURR, T.R., and BARCZA, N.A. The refining of ferrochromium metal. *S.Afr. Pat. 82/7403*. Assignees: The Council for Mineral Technology and Middelburg Steel & Alloys. Aug. 1983. 11 pp.
29. HERLITZ, H.G. SKF Steel's plasma technology. Quality improvement and cost reduction. Hofors (Sweden), SKF Steel Engineering AB, *Technical Report 1/1984*. 15 pp.
30. ANON. Reduction by plasma metallurgy. *MPT*, vol. 5. 1984. 100 pp.
31. ANON. Samancor's chrome showing strength. *Metal Bulletin*, 24th Jun., 1983. 15 pp.
32. SCHOUKENS, A.F.S., and CURR, T.R. The production of manganese ferro-alloys in transferred-arc plasma systems. *Proceedings, 42nd Electrical Furnace Conference, Toronto, 4-7 December, 1984*. Warrendale, Iron and Steel Society of AIME, 1985. pp. 161-171.
33. KNOPPEK, T. The Voest Alpine plasma furnace after one year's operation. *MPT*, vol. 1. 1985. pp. 11-16.